

Assembly Instructions BR 14x-2

Box Body Kits

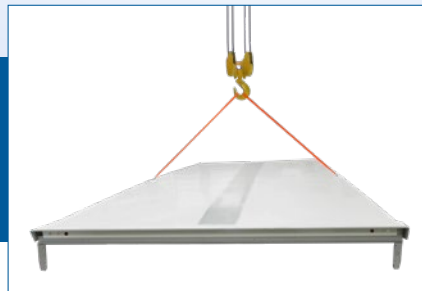

MA14x2.UK

Always read through these instructions, completely and carefully, before you start the assembly work.



Table of Contents

1. Safety Instructions and Warnings	2
1.1 Checking the kit contents	2
1.2 Warnings	2
1.3 Safety instructions	3
1.4 Copyright	4
2. Preparatory work / Personnel requirements	4
2.1 Personnel requirements	4
2.2 Tools and equipment required	4
2.3 Tightening torques for screws and bolts	4
2.4 Preparations	5
3. Assembling the Kit	5
3.1 Installing the walls	5
3.2 Installing the bottom frame crossmember	6
3.3 Attaching the roof	6
3.4 Wiring the kit and fastening the roof	6
3.5 Installing the doors, top gate or roller shutters	7
3.6 External sealing	8
3.7 Body on the subframe	8
4. Completion Work	9
5. Maintenance, Service	11
5.1 Maintenance	11
5.2 Service	11
6. Disposal of Old Box Bodies and Components	11
7. Kit Contents	12

1. Safety Instructions and Warnings



These instructions explain how to assemble kits 140-2 to 146-2. To create a fault-free body **always follow the work instructions described here**, in particular, the following warnings, **otherwise the warranty is voided**.

If you have received a custom design, it is possible that some work steps are not explained here. Please also note that coloured representations are for illustration purposes only. **Get in touch with us immediately in case of uncertainties.**

1.1 Checking the kit contents

Check the delivery against the enclosed packing list for completeness. Notify the delivering carrier immediately of any transport damage. Please understand that we must reserve the right to make changes to the design, features and technology delivered. The general kit contents are listed on page 12.

1.2 Warnings

AluTeam generally does not know the precise intended purpose of the kit. **As the body builder, you must match the order and use of the kit to the requirements of your customer and the body guidelines of the vehicle manufacturers.** This also applies to materials used and surface finishes. Damage due to transport goods such as aggressive chemicals are not a reason for complaint.

- Store the kit in a dry and clean place (not outdoors).
- To ensure that water cannot get into the assembled box body, the sealing cords in the sections must not show any signs of damage.
- Connect the components directly using the screws supplied. The assembly contact surfaces must be free from dirt.
- Never position screws or bolts at an angle. The screws must not tilt. Keep to the specified torques (2.3). Tightening to torques less than those specified weakens the strength of the system, significant exceedance of the specified torques can cause damage to components!
- use the original screws and bolts, and use them only once! Third party or used screws or bolts endanger operational safety. **Always use new AluTeam screws and bolts**, even for repairs.



suspended loads
on the crane



falling
objects



toppling parts
or assemblies



Risk due to
high-pressure
cleaners



hazardous
materials



Risk of
scalding

1.3 Safety instructions

Pay attention to your own safety and to that of your employees.

Working with kits involves hazards. Therefore, caution is always necessary, in particular, you should definitely:

- ... **Wear safety gloves**. Wear **safety footwear**, as heavy parts can fall. Wear **hearing protection** as well as **safety goggles** when working with air screwdrivers, drills, grinding equipment, etc. Wear a **helmet** when working with or near a crane.
- ... when unloading / transporting the kit in the transport rack using a crane, use a suitable lifting beam. If using a forklift truck, push the transport rack completely onto the fork arms.
- ... Place kits only on level surfaces and secure them against inclination, tilting, toppling.
- ... Always lift assemblies vertically, not at an angle! Never step under suspended loads! The suspension point/anchorage in the crane must always be above the assembly's centre of gravity!
- ... remove all packing straps in the specified order during assembly, always remove the white packing straps first. The individual components and assemblies are held by a red packing strap. Secure the part to be removed against toppling before cutting the packing strap.
- ... if using an assembly dolly, secure it against rolling away.
- ... lift the roof with a lifting beam or vacuum lifter only! The roof mounting strips (airline rails) are used as an assembly aid only. They must not be used to lift assembled box bodies. **Risk of pulling out!**
- ... comply with all relevant legal requirements in your country, such as laws, regulations, etc. regarding road traffic and goods transport, as well as all relevant occupational health and safety regulations. This is the responsibility of the body builder.
- ... ensure adequate ventilation when cleaning and sealing and follow the use, safety and disposal instructions of the adhesive / sealant manufacturer. Request the safety sheet and the instructions for use from the manager, as printed on the cartridge or contact **+49 (0)521 4173-1110 (Fax -1190)**.

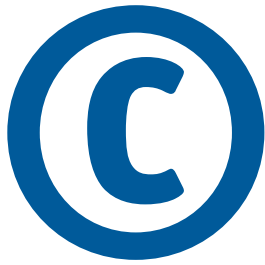

1.4 Copyright

AluTeam holds the copyright to these instructions. They are intended for the assembly company and its personnel and may not, neither as a whole nor in part, be:

- reproduced
- distributed or
- otherwise disclosed.

Infringements can result in civil and criminal charges!

2. Preparatory work / personnel requirements

AluTeam kits can be assembled in any well-equipped workshop. Carry out the following preparations beforehand.

2.1 Personnel requirements

1-2 fitters with training as a vehicle or vehicle body builder or equivalent training are required.

2.2 Tools and equipment required

Before starting the assembly, make sure the following equipment is to hand:

- Measuring tape
- Precision air or cordless screwdriver with torque setting (e.g. Fein Accutec or compatible)
- An extension for screwdriver bits may be useful
- Torque wrench up to 200 Nm
- 4 Single-stud fittings (LoadLok 5018 or allsafe JUNGFALK 7105/75018)
- Ratchet with sockets for hexagon screws/bolts M6, M10, M12
- 4 wood panels approx. 300 x 300 mm (at least 20 mm thick), squared timber, or similar
- Pneumatic or manual dispenser gun for 310 ml sealant cartridges
- Rivet gun for rivet diameter 5 mm
- Crane with at least 1 tonne working load limit and vacuum lifting beam or lifting gear
- Punch d = 3 mm and d = 4 mm
- 2 standing ladders or scaffold unit
- HSS drill bit Ø 5,0 mm
- Painter's putty knife

2.3 Tightening torques for screws and bolts

The settings at the power screwdriver for the assembly screws/bolts must be checked using appropriate measuring equipment. The torques apply on the nut side, with dry thread. **Set the following torque:**

- | | |
|------------------------------------------|---------------|
| ○ Assembly screw M 6 x 21 (MD100224) | 10 Nm ± 1 Nm |
| ○ Countersunk screw M 10 x 30 (MD100268) | 52 Nm ± 5 Nm |
| ○ Frame screw M 12 x 45 (MD100307) | 125 Nm ± 5 Nm |



2.4 Preparations

- The ambient temperature for components as well as adhesives and sealants must be at least 15°C. Ensure that the required tools and equipment (2.2) are to hand.
- Secure the complete kit against toppling, as well as the individual assemblies. Store them on the pallet in the order required for assembling the body. Do not cut the red straps, which secure a component, until you need to remove the component.
- Carry out the assembly on a level floor. To protect the painted components and for easier alignment, place wooden boards 300 x 300 mm, 20 mm thick or similar on the floor front wall / under the corners and at under the side wall and side wall / rear frame. The corner pillars must remain clear from the bottom up, cables may still have to be laid here.
- In case of "Latt um Latt" (batten by batten) kits, remove the bottom 2 - 3 rows of battens, in order to be able to lay the floor properly and easily.
- If you have received a one-piece floor panel from us, start with the floor installation as described in the instructions supplied.

Attention: The fastenings between the longitudinal chassis beams and the chassis frame must be made as described in the body guidelines of the respective vehicle manufacturer. The two front fastenings at least must be spring-mounted. Otherwise, forces that occur, e.g. in case of cornering, load changes or non-uniform loading, are transferred onto the body and can cause cracks in the body structure.

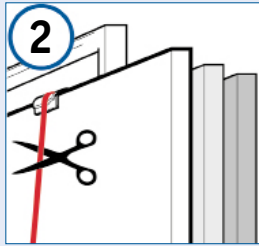
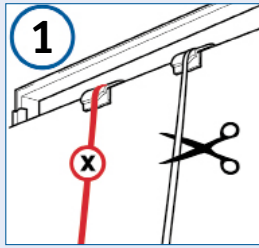

3. Assembling the kit

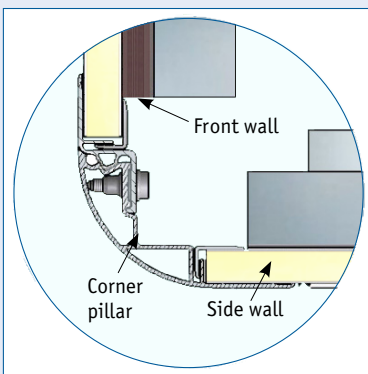

3.1 Walls

- Use the crane and lifting gear (with claws and lifting beams) or vacuum lifting beam, to remove the front wall from the transport unit. Place it centred on the boards or square timbers previously placed on the floor and secure it against toppling.
- Also remove the first side wall and push it onto the front wall at right-angles and put it down. The wall remains standing in the crane, one fitter secures the assemblies on the outside.

The 2nd employee screws in 3-4 screws MD 100224 on the inside to a torque of 10 Nm \pm 1, starting from the bottom up to approx. $\frac{3}{4}$ of the box height, until the sections are pressed together. Use the punches as an assembly aid if necessary.

Tip: For kits with interior wall panelling, we recommend using a 100 mm bit extension or a flexible bit holder.

- Position the second wall in the same way and align it at right-angles with the front wall. The wall remains hanging from the crane initially. Starting from the bottom, screw in 3 - 4 screws MD100224 on the inside, up to approx. $\frac{3}{4}$ of the box height until the sections are pressed together and the required torque (10 Nm \pm 1) is reached.

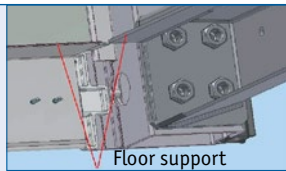

3.2 Installing the bottom frame crossmember

- Position the bottom frame crossmember supplied between the frame pillars.
- Fix the crossmember from the outside of the pillars with 4 screws M 12 x 45 mm each. Do not tighten the screws yet!
- Check, and correct if necessary, the angularity and diagonal dimensions of the parts assembled until now.

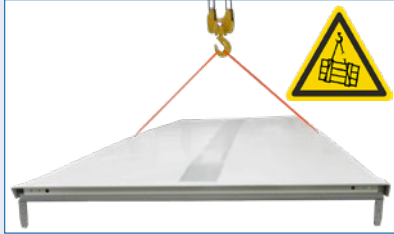
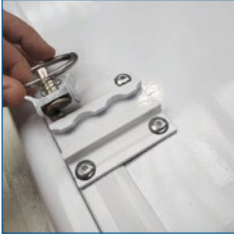

3.3 Attaching the roof

- If a kit includes doors, undo the lashing straps of the doors before attaching the roof. However, the doors must remain secured against turning.
- Use the crane and lifting gear or vacuum lifting beam to remove the roof from the transport unit. Place it in a horizontal position and, if necessary (if you are working without a vacuum lifting beam), hook the single-stud fittings into the roof assembly rails. The fittings must be tight!
- Clean the preassembled roof corners (front and rear) on the inside using bond-activating cleaner and leave it for approx. 4 minutes to flash off and dry. Then apply a sealant on the inside sealing surfaces.
- The top frame gusset plates are pushed sideways into the frame crossmembers and fixed. Undo the fixing and turn the frame gusset plates until the pointed tip points downwards.
- Use the single-stud fittings or the vacuum lifting beam to lift the roof. Centre the roof, starting from the front, on the top rail of the front wall (bulkhead). The roof caps grip over the corner pillars. Align the roof with the wall sections.

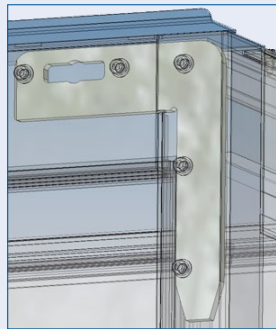
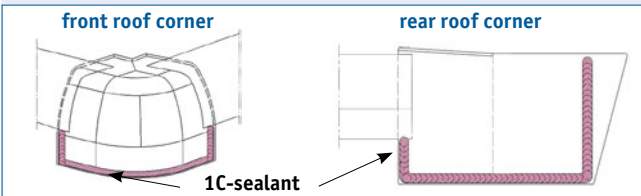

Attention: Never stand under raised loads, lift the roof only if it is in a horizontal position, never suspended at an angle!

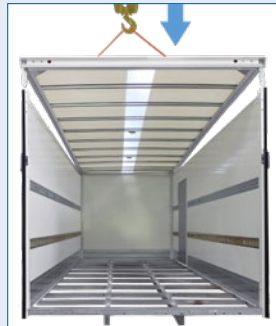

3.4 Wiring the kit and fastening the roof

- Lower the roof slowly. Use a painter's putty knife as an assembly aid. Centre the downward pointing frame gusset plates in the pillars. Fix the gusset plates on each side with three countersunk screws M 10 x 30 (MD100268).
- The cable connections of the series 14x-2 kits can be installed very easily as follows:
 - To **wire the side lights**, simple **1.** connect the connectors and push **2.** the plug-in connection (right) downwards into the **right frame pillar**.

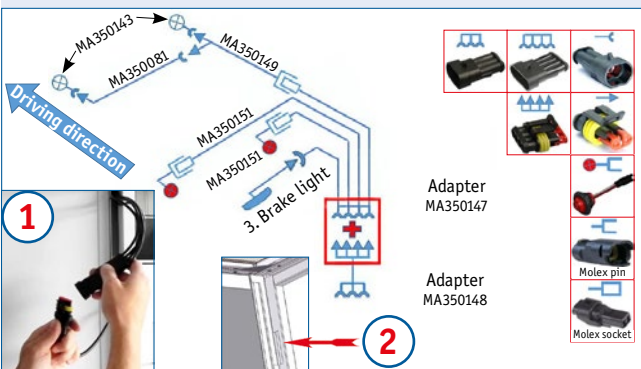

Attention: The cables and connectors must not be crushed.

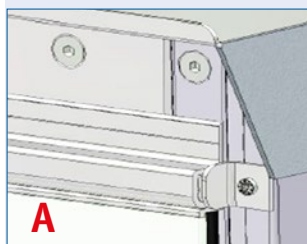
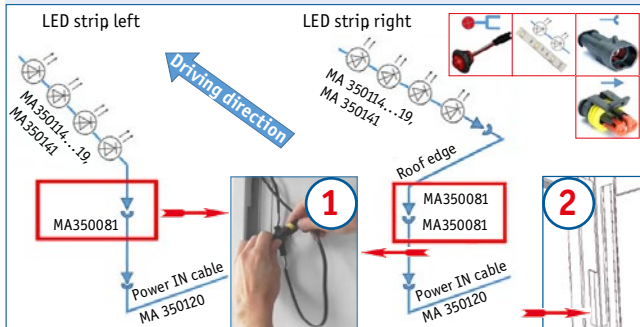
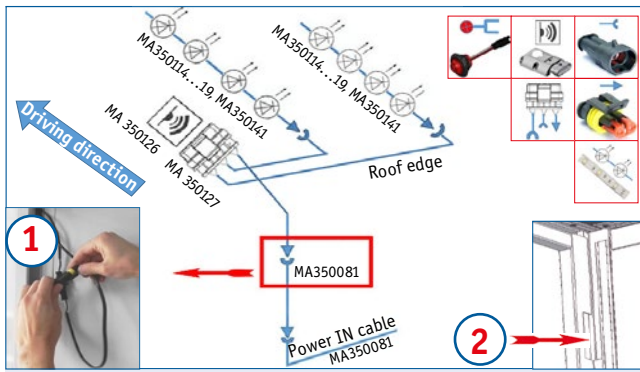

- Now continue to connect the various lights:
 - To **wire the LED strips with motion detectors (infrared sensor)**, fit together **1.** the connectors only and push **2.** the plug-in connection downwards into the **left frame pillar**.
 - To **wire the LED strips without motion detectors (infrared sensor)**, fit together **1.** the connectors only and push **2.** the plug-in connection downwards into the **left frame pillar**.

Note: The figure shows wiring with LED strips on the right and / or on the left-hand side.

- Fix the roof on the front wall with 3 - 4 screws spread over the width of the front wall and tighten with the required torque.
- Measure the diagonals of the frame and correct them until they are identical.
- Tighten the screws of the frame gusset plates at the top to a torque of approx. 52 Nm, the screws of the bottom frame crossmember with approx. 125 Nm. The rear surface of the crossmember must form a flush plane with the rear surface of the pillars.
- Remove the single-stud fittings from the roof assembly rails. Screw the pillar connections from the bottom up, the front wall/ roof connection crosswise and the side wall/ roof connection from the front to the rear, each with the correct torque.
- If the box has a slide sliding door with restricted installation space above the door frame, a torque wrench is essential to connect the side wall/ roof, setting: 10 Nm ± 1 Nm.
- In case of a roof with integrated tail-lift seal, bond the end of the seal onto the frame pillars and fix it with a screw.

3.5 Installing and adjusting the doors, top gate or roller shutters

- If a top tailgate is planned, fix it onto the roof flange using the holes provided in the hinge and assembly screws 6.3 x 22 mm (included in the top gate material).

Latch the gas springs of the gate onto the ball heads. In case of a frame pillar without integrated seal, use 2 brackets to secure the gate against lateral movement during operation **A**.

If the frame pillar has an integrated seal, use the assembly screws to secure the gate against lateral movement **B**.

- If the gate has butt hinges, the hinge brackets are fixed on the roof. Insert the hinge leaves here. Push in the hinge bolt and secure it.
- Frame doors are preassembled on the side walls. Close the doors and **check the fit**.
- If there are large deviations, an assembly error probably exists. In case of smaller differences, adjust the doors using the screws in the hinge leaves; in case of integral doors or doors with external rotary bars, adjust using the hitches on the frame crossmembers. **Check the screws for tight fit!**
- Roller-shutters and stainless steel frames are delivered unassembled. In the middle header you will find a link plate for the lifting gear. Remove the frame from the transport unit and push it onto the walls. Screw in the screws until the sections are pressed together. In case of a roller-shutter door, continue as described in the instructions enclosed with the door. Pay attention to the contour lamp cable protruding from the pillars – **Risk of damage**.



3.6 External sealing

- Remove the sealant that emerged inside at the roof corners.
- Clean the external sealing surfaces with bond-activating cleaner and leave for approx. 4 minutes to flash off and dry. ①
- Seal all round the front roof corners . ②
- Seal all round the rear roof corners as well as the roof edge - frame pillars connections, not only at the respective top end of the pillars, but also the top contact surfaces between the corner pillars and the frame crossmember with sealant. ③
- Seal kits with top tailgate above the tail-lift as described in the drawing. ④
- In case of kits with roller shutter or steel or stainless steel frame, the frame crossmember must be sealed between it and the roof across its the complete width.
- If the kit has a side door, the connection of the side door frame to the floor must also be sealed.

Attention: Smooth the seals with water only, without soap additives. ⑤

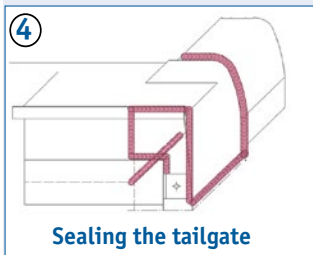

Note on AluTeam substructures

In case of AluTeam substructures, use the assembly instructions enclosed with them. We recommend that you assemble the sub-frame directly on the horizontally aligned and torsion-free chassis.



3.7 Body on the subframe

Follow the body and conversion guidelines of the respective vehicle manufacturer, in particular the positioning and type of subframe connection, flexible or stiff under shear. **Forces acting on the rear bumper guard must be able to be safely transferred into the auxiliary frame or chassis.** The frame and the body are not designed to absorb forces caused by docking operations!

As a minimum, the two front fastenings between the longitudinal chassis beams and chassis frame must be spring-mounted. Otherwise, forces that occur during driving, e.g. in case of cornering, load changes or non-uniform loading, are transferred onto the body and can cause cracks in the body or substructure.

In general, possible adjustment work such as drillholes must be carried out by the body builder and are not a cause for complaint.

- Position the subframe or chassis, aligned horizontally and torsion-free, on a level surface. In case of semitrailers with a step the drop-centre must be absolutely parallel with the high-centre and must be torsion and stress-free.
- In case of bodies with multi-leaf side doors, if necessary, stiffen the subframe in the area of the side doors as well as approx. 1 m to the right and left of it. If necessary, the stiffening must be extended over the full length. The body builder is responsible for this work.

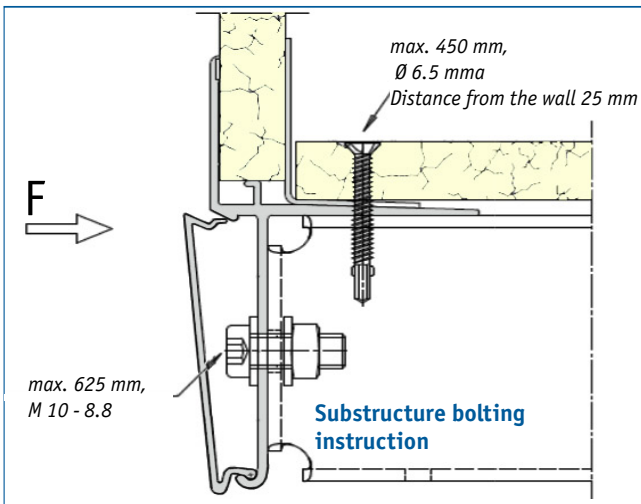

- In case of bodies with side-entry door doors with low entry, you must stiffen the subframe at the side-entry door as well as approx. 1 m to the right of them, especially in the area of the step; e.g. stiffen with gusset plates. The body builder is responsible for this.
- In case of sliding side doors, always ensure free and easy movement of the vehicle wheels in the area of the runner.
- Use the crane and lifting gear to position the finished box body on the auxiliary frame or chassis. Never lift the assembled box body by the roof eyebolts. **Risk of pulling out!**
- Fasten the box body on the subframe as shown in the drawing on the left. If this **bolting instruction** is not followed, the warranty is voided.

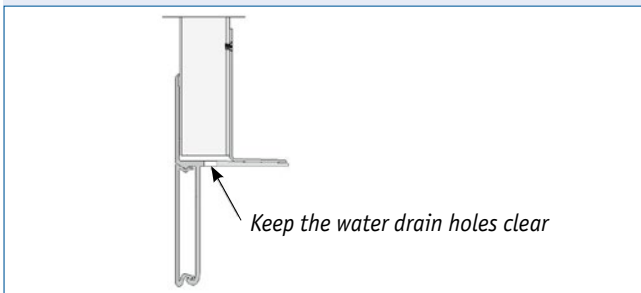

Attention: The condensation drain holes of the bottom rail sections of series 140-2 and series 142-2 as well as the water drain holes of the side gates and side doors must remain clear even after they have been mounted on an subframe!

4. Finishing Work

- The vehicle builder is responsible for the installation of floor boards. Take into consideration their swelling behaviour and ask your panel / board supplier. **Seal between the floor and the body!**
- In case of box kits with “Latt um Latt” (batten by batten) feature, after the floorboards/panels have been laid, the bottom two or three rows of battens must be screwed back on again. Correct installation of the battens is the responsibility of the body builder.
- Use the plugs supplied to close off the side screw holes in the rear pillars.
- Then, depending on the body features, pull the connect cable for the side lights out of the frame pillar and connect it to the connection cable of the respective vehicle manufacturer.
- Latch the cover into the bottom rail section. Place the cover in the clean (cleaned) bottom groove and knock or press it in from one end, starting from the top. Depending on the kit length, this is a task for 2 employees.

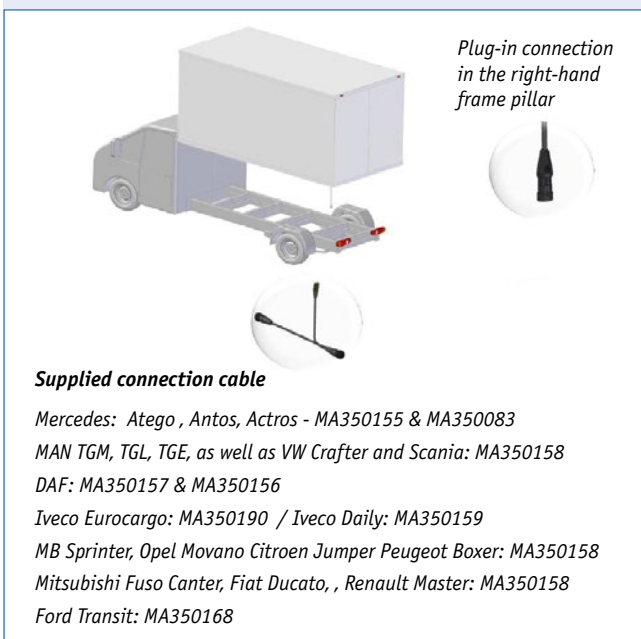

Attention: If box bodies are unpainted, you should not attach the cover until after the painting, in order to prevent corrosion damage

- After mounting the covers, use bond-activating cleaner to clean the remaining vertical gap between the bottom rail and the cover and the respective front and rear pillar.

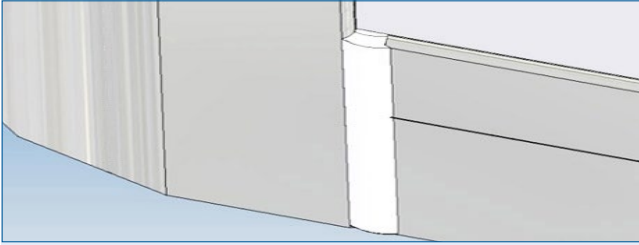

Attention: Paints, solvents and dust are harmful to health. Protect yourself!

- Then seal it with 1C sealant (*as shown in the sketch on the left*)
 - If necessary, screw the inside right handle onto the frame pillar.
 - You can generally paint over our coil coating and powder coated parts with traditional wet paints. For reliable bonding, consult the paint supplier, particularly regarding the primer.
Untreated and galvanised sections must be treated with a suitable primer before painting. Grind the finish-coated parts supplied with the abrasive pad and remove dust and grease to prepare them for painting. The temperature in the paint booth must not exceed 60°C.
 - In case of subsequently mounted attachments or changes to AluTeam components, pay particular attention to corrosion protection. **Above all, you must always prevent contact corrosion caused by different materials.** Otherwise the painting and coating warranty is voided.
 - Check the roof corners, doors and lighting for leaks, e.g. perform a water test on bodies, based on EN 283 (Swap bodies. Testing) Test the external seal welds with a water jet from a 1/2" nozzle (Ø 12.5 mm inside), at a pressure of roughly 1 bar. The nozzle must be held at a distance of approx. 1.5 m from the body. After the test, there must be no penetrated water in the body.
 - The assembled box body can be handled; however, it cannot be loaded. Note that the final strength of the sealant (at 20 °C) is not reached until after 24 hours.
- Attention:** You must wait at least 6 weeks before cleaning the body with a steam jet cleaner. Please always note the explanations regarding this in "5. Maintenance, Service".

5. Maintenance, Service



5.1 Maintenance

For the body maintenance, check all screws and bolts for tight fit at regular intervals; however, at least once a year. At the same time, check the specified torque.

- Locks and lock cylinders are maintenance parts. Lubricate them to keep them in working order if necessary. Frozen locks due to lack of maintenance are not a reason for complaint.
- When cleaning the body with a steam jet cleaner (after 6 weeks at the earliest) maintain a minimum nozzle distance of 300 mm. The maximum allowable water temperature of the cleaner is 60°C, the working pressure is 100 bar, and the pH-value is 4 - 10. Rinse immediately with clean water. Remove flash rust on stainless steel (including the frame) using common household stainless steel cleaners.
- After cleaning, always clean all seal with a rubber care product.

5.2 Service

If you have any questions regarding the assembly, please contact our **customer service**: **Tel.: +49 (0)521-41 73 11-30,**
Email: m.wismueller@aluteam.de

If you require **spare parts**, please contact either your local sales representative or call us on: **+49 (0)521 - 41 73 11 - 10.**

Please send emails to: info@aluteam.de

6. Disposal of Old Box Bodies and Components









- You **can remove the metallic outer layers** from the foam core and, like the aluminium sections, hand them over to the scrap trade for recycling. The same applies to the steel and / or stainless steel components of the frames.
- A **PUR foam core** can be incinerated in thermal waste treatment plants without polluting the environment. **Plywood**, like particle-boards, can be burned in wood-fired furnaces with at least 50 kW nominal heat output. They are subject to stricter carbon monoxide limits than solid wood. These values are mostly only achieved by automatically loaded plants. Odour nuisance due to the ammonium additives in the binders must be avoided.
- **GRP** must be processed by a recycling/recovery company, and is used as a substitute fuel. For energy recovery in a cement works, the EWC code is 070213 (waste plastic).
- For information on disposing of the **foam in the area of the floor**, contact the trade association for extruded polystyrene foam (In Germany: Fachvereinigung Polystyrol-Extruderschäumstoff (FPX), Od-enwaldring 68, 64380 Rossdorf (<https://xps-spezialdaemmstoff.de/wp-content/uploads/OPS-MIT-cogeneration-Transmittent-1.Pdf>))
- **Hardened adhesives and sealants** are disposed of as residual waste (black bin). **Residual quantities of solvents**, as hazardous waste, must be handed into the respective disposal company or collection point. The technical data sheets can be requested from the individual manufacturers.

7. Kit Contents



Please understand that we must reserve the right to make changes to the design, features and technology delivered.

A BR14x-2 kit includes:

- Front wall assembly
- 2 x side wall assemblies, right and left, including rear pillars and, depending on the features, with attached doors
- Roof assembly with integrated frame crossmember, including frame gusset plate as well as preassembled roof corners
- Optional rear steel frame, e.g. in kits with roller shutter frame
- In case of liftgate kits: Top tailgate with pneumatic spring and Assembly screws MD100058 as well as, depending on the gate version, material for fixing the gate at the side 
- Bottom frame crossmember, depending on the features
- Assembly screw M 6 x 21 Tx30 self-locking, AluTeam Article No.: MD10022 
- Countersunk screw M 10 x 30 galvanised, AluTeam Article No.: MD 10026 – Aluminium pillar connection to roof 
- Screws M 12 x 45, MD 100307 for connection the aluminium pillars to the bottom frame crossmember 
- Plugs for bolting holes in the frame pillars 
- Handle MA200152 with self-tapping fastening screws MD100202 
- 1C-sealant and adhesive, bond-activating cleaner
- If necessary, a connection cable for truck chassis, as in the order (*see circuit diagram*)
- If a side door is supplied (as part of the side wall), optional drip moulding above the door, including mounting material
- Paper towels
- Sticker with body number
- *Optional* sticker "Tested load restraint"
Attention: *The sticker is only valid with a certificate issued by AluTeam*
- Assembly Instructions